

■ Помоги художнику дорисовать и закрасить игрушки.

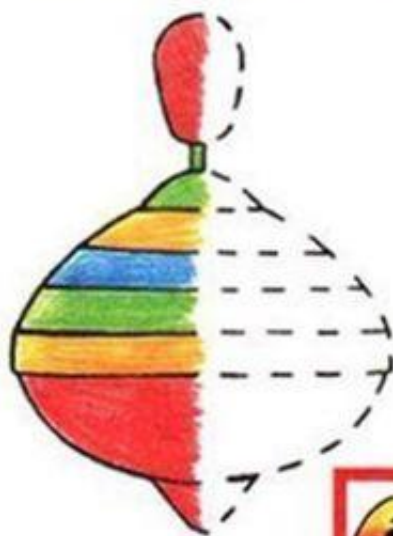
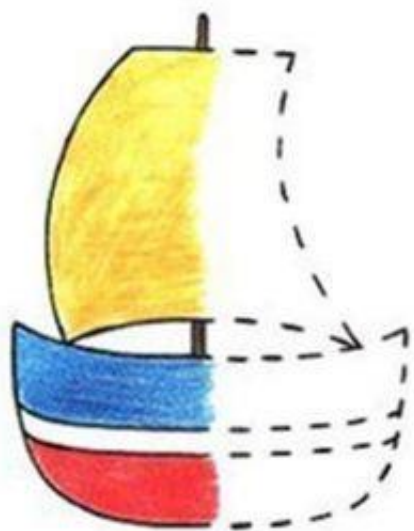

ATIVIDADE

EU SOU: _____

1- SIGA A LEGENDA DE CORES EM DESTAQUE E CONTINUE COLORINDO AS BORBOLETAS.

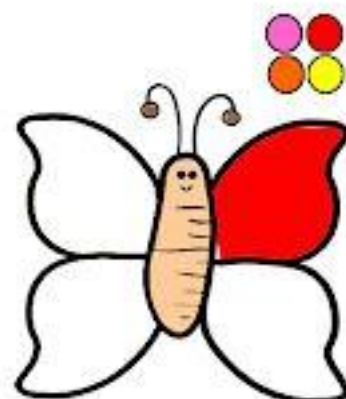
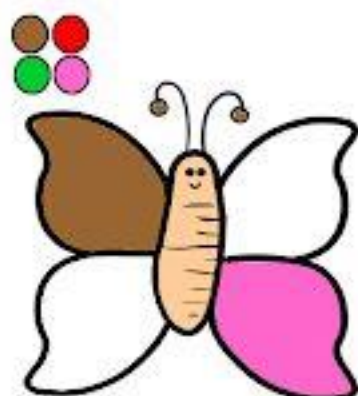
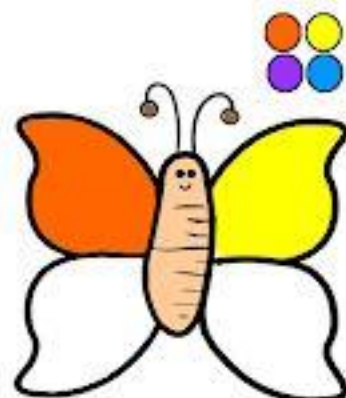
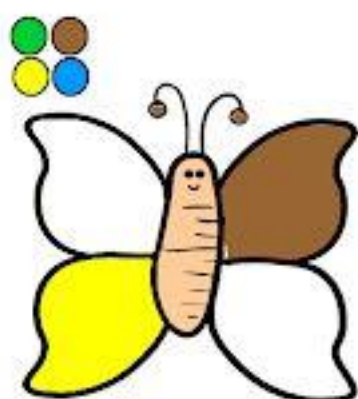
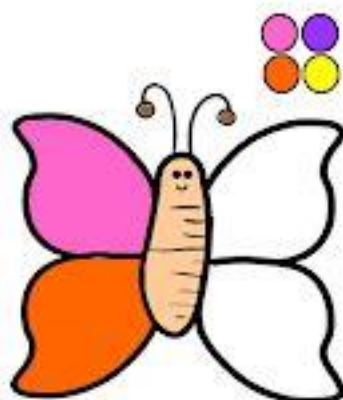
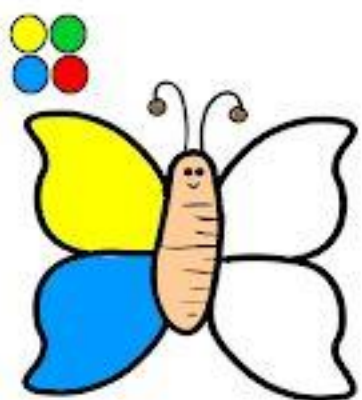

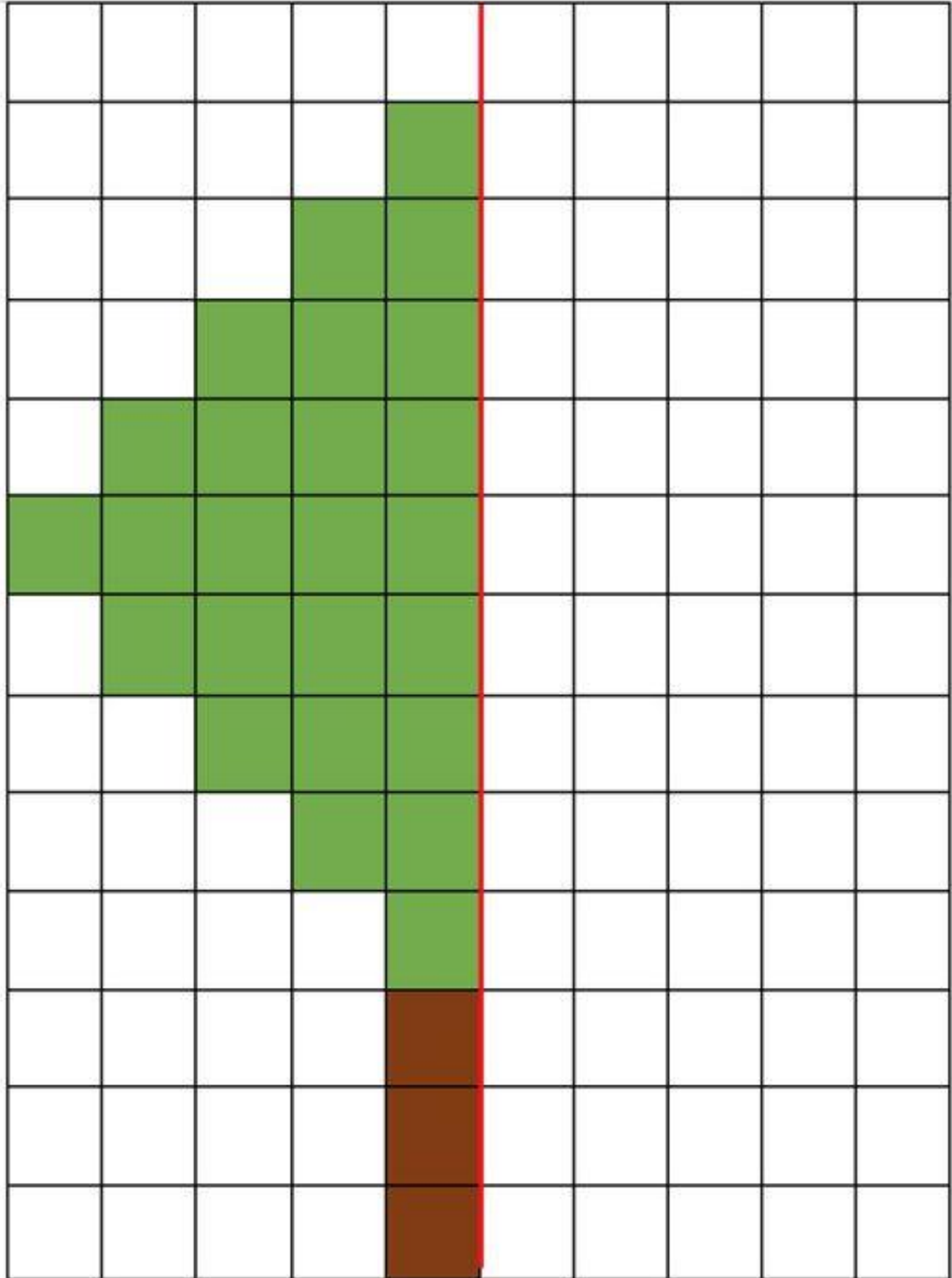

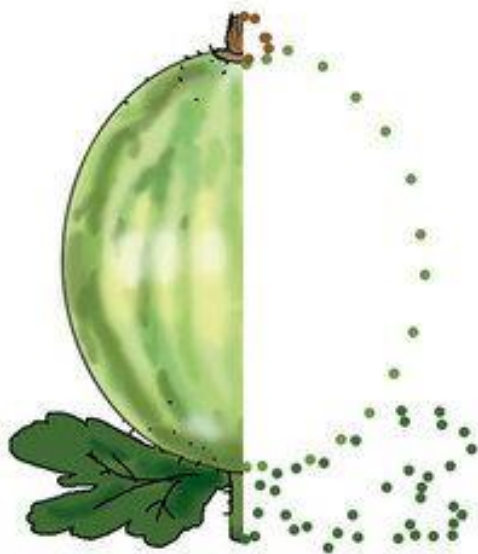
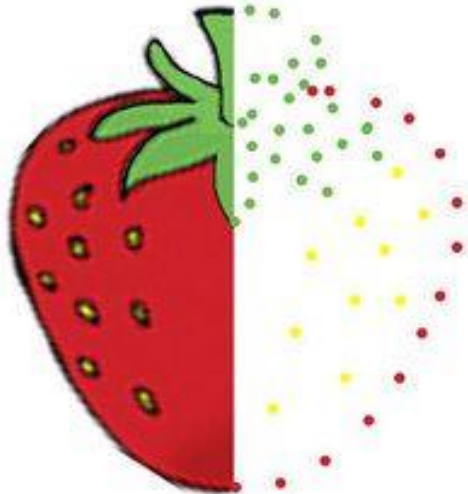
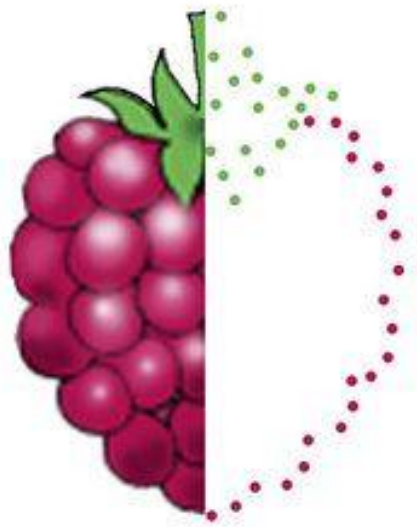

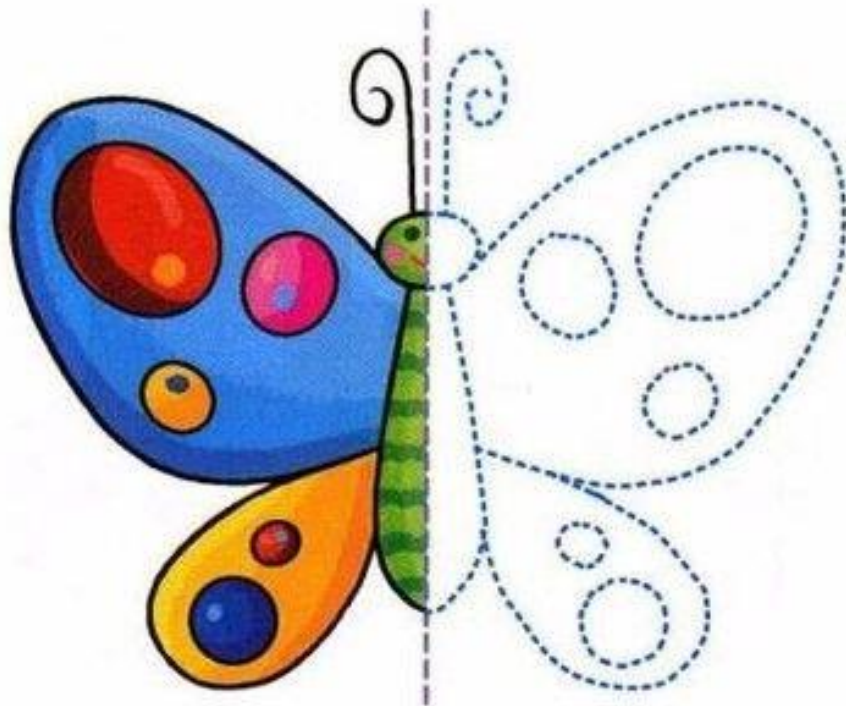
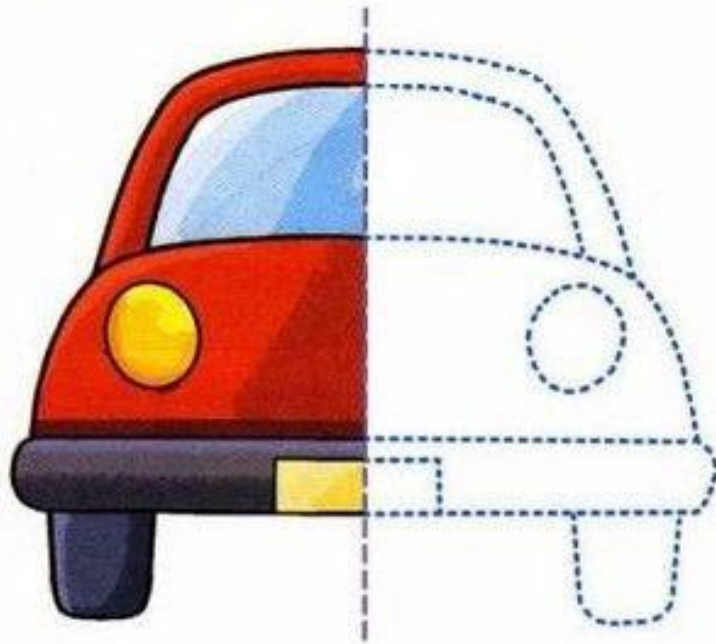

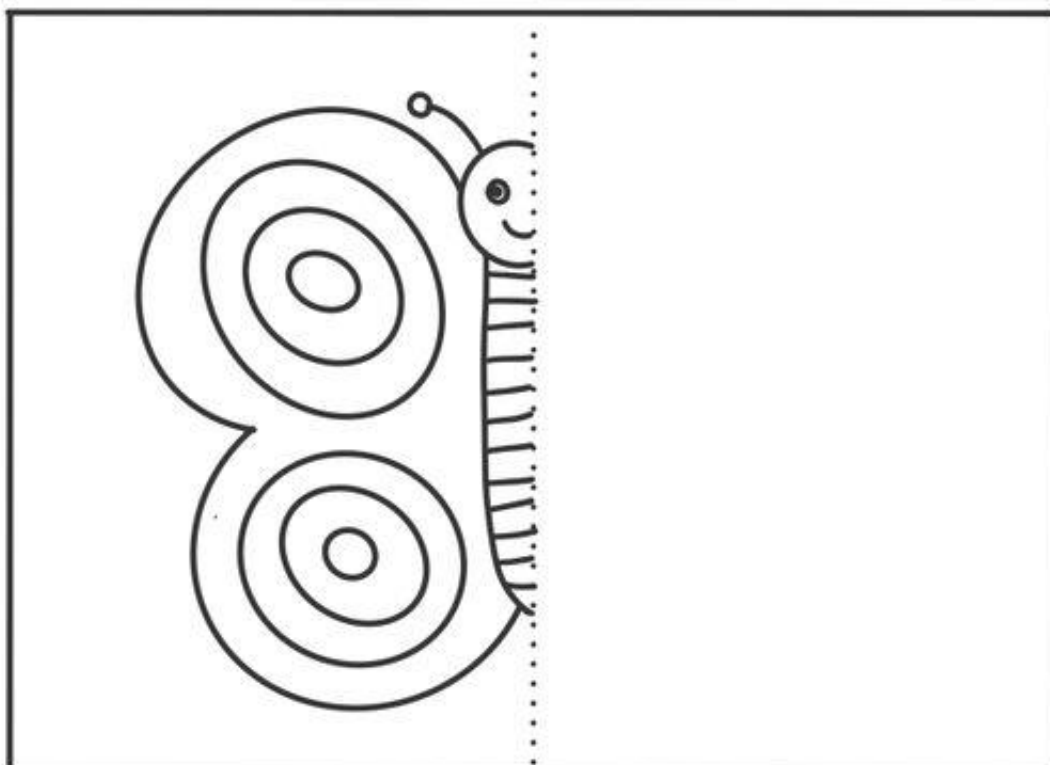
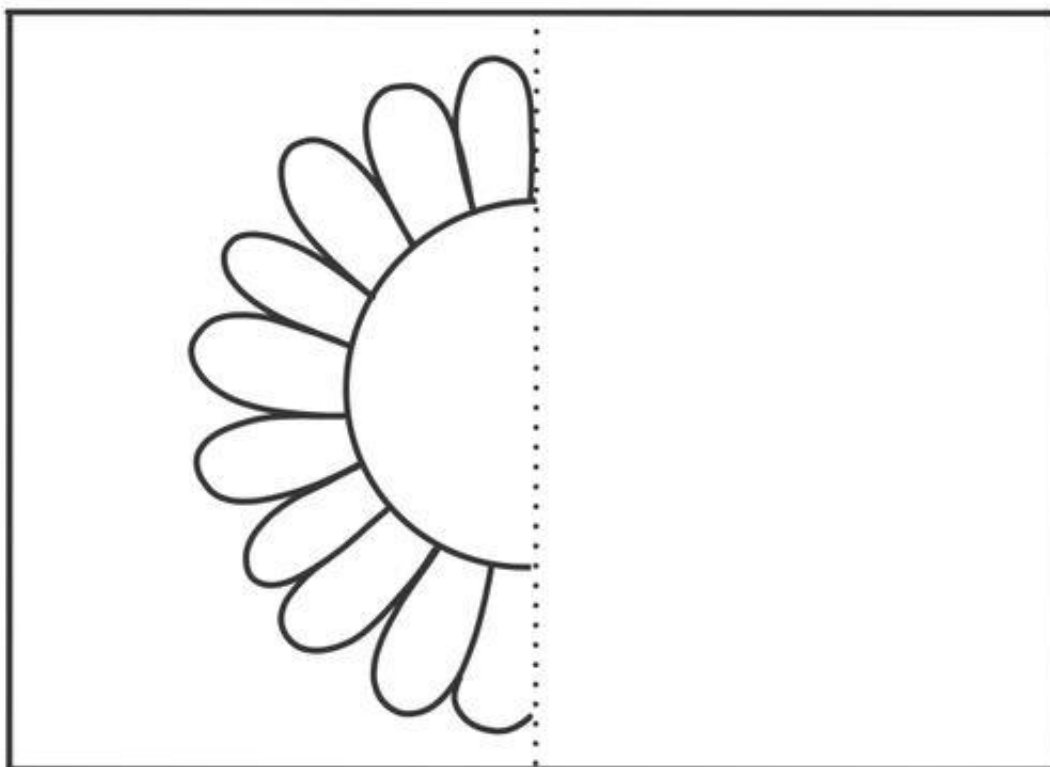

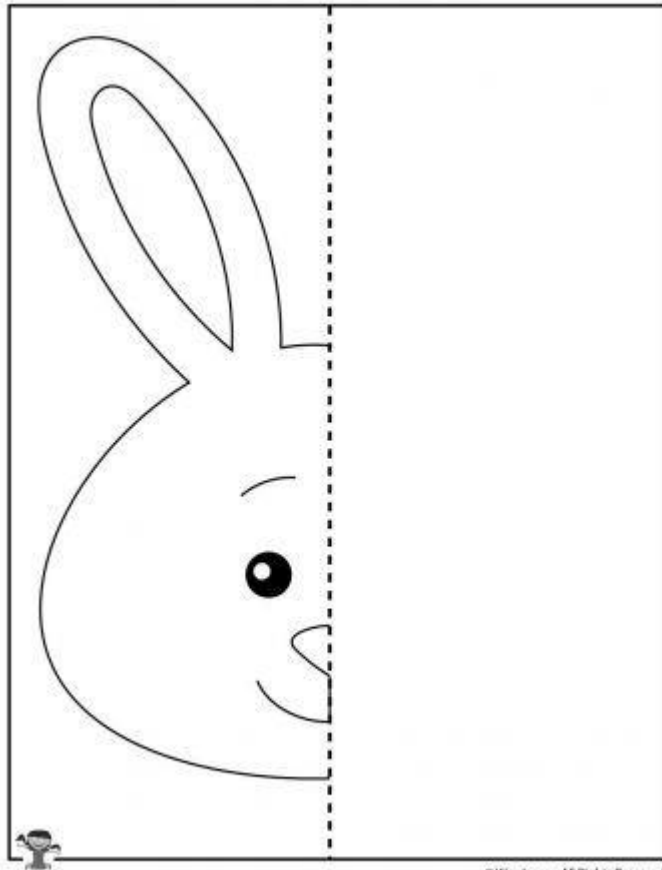

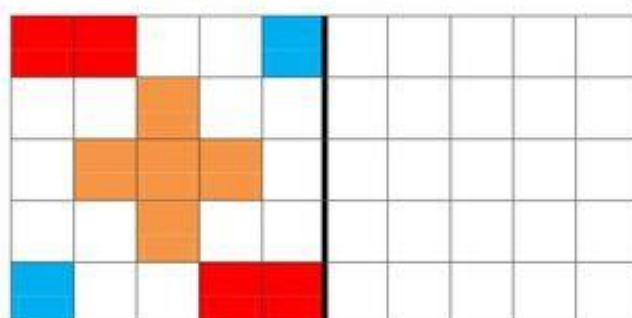
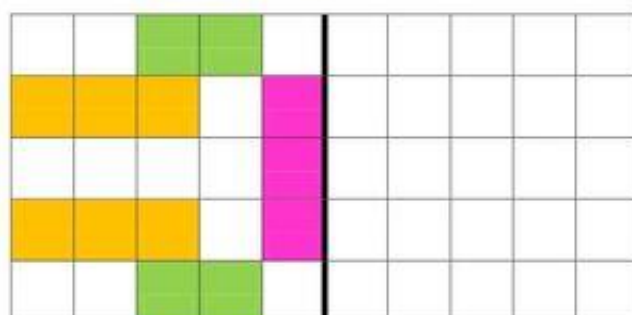
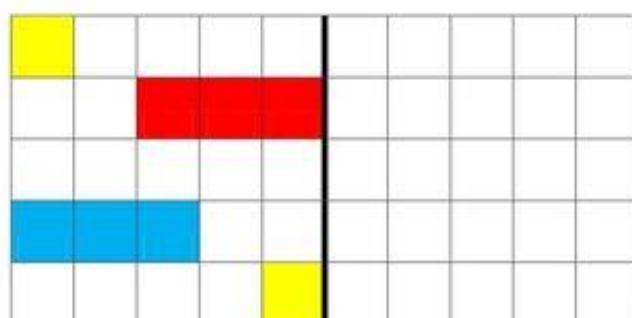
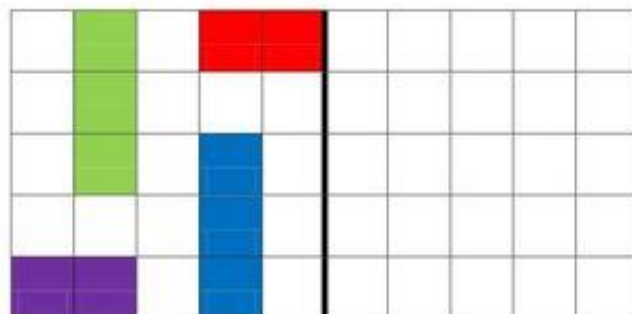

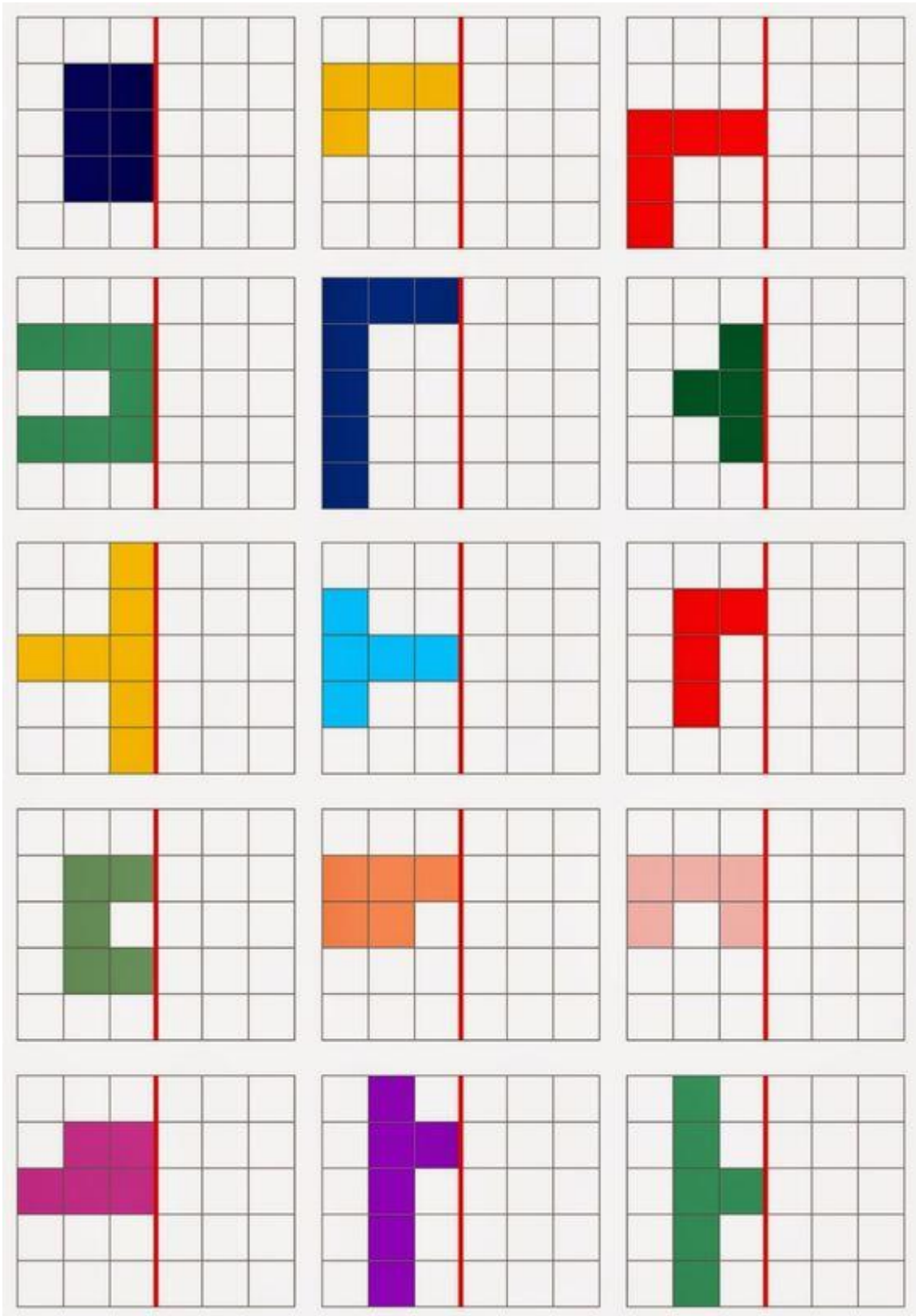

.....

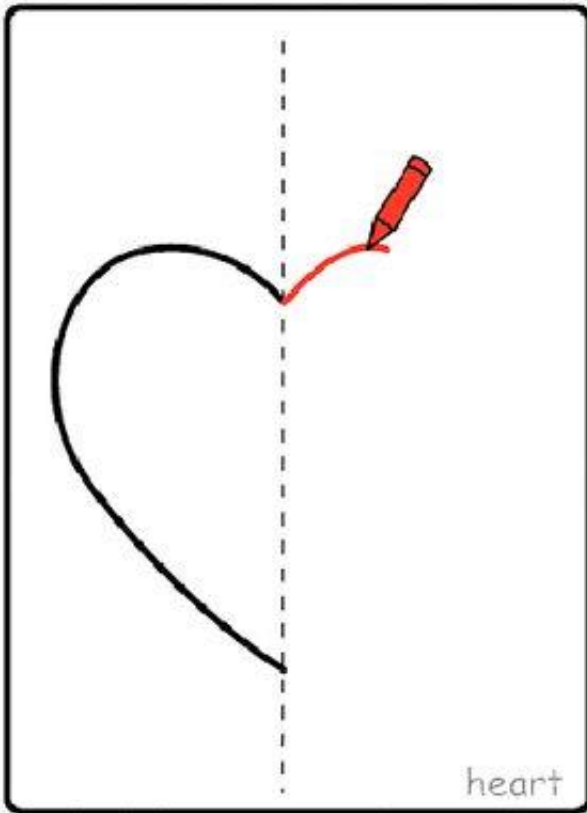

heart

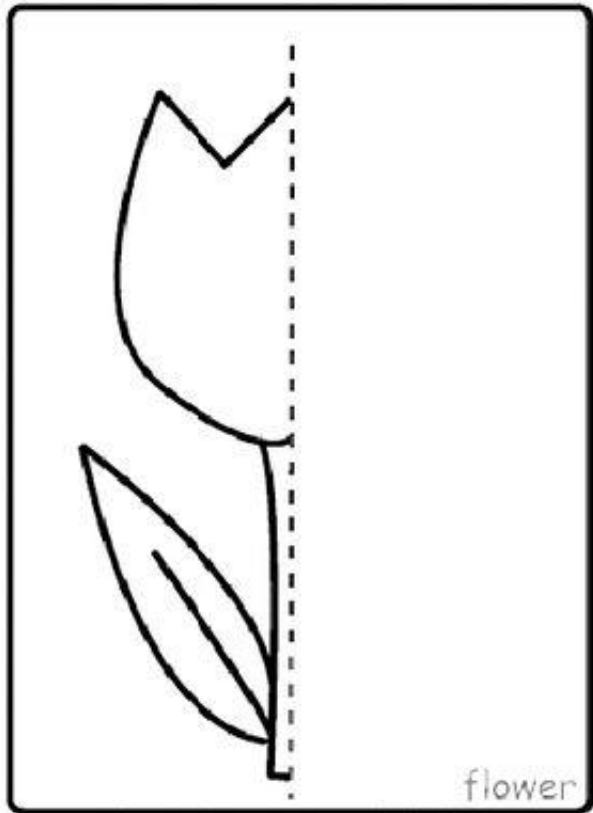

flower

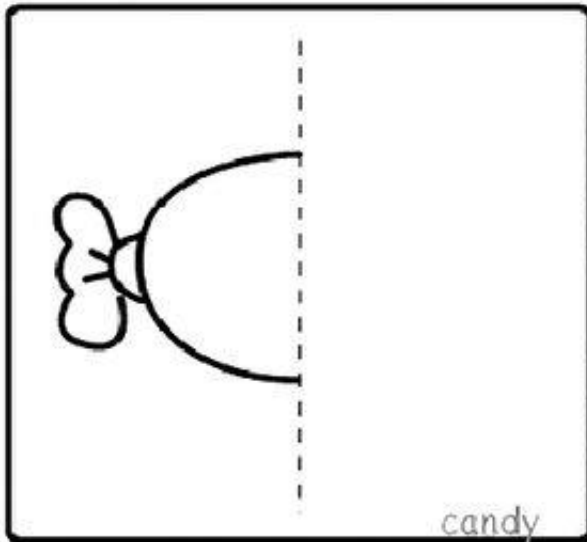

candy

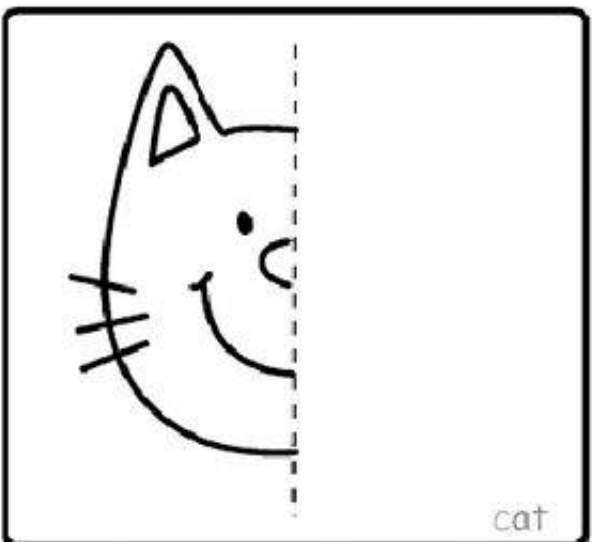

cat

Naam: _____

Maak dit ijsje af: kleur de vakjes

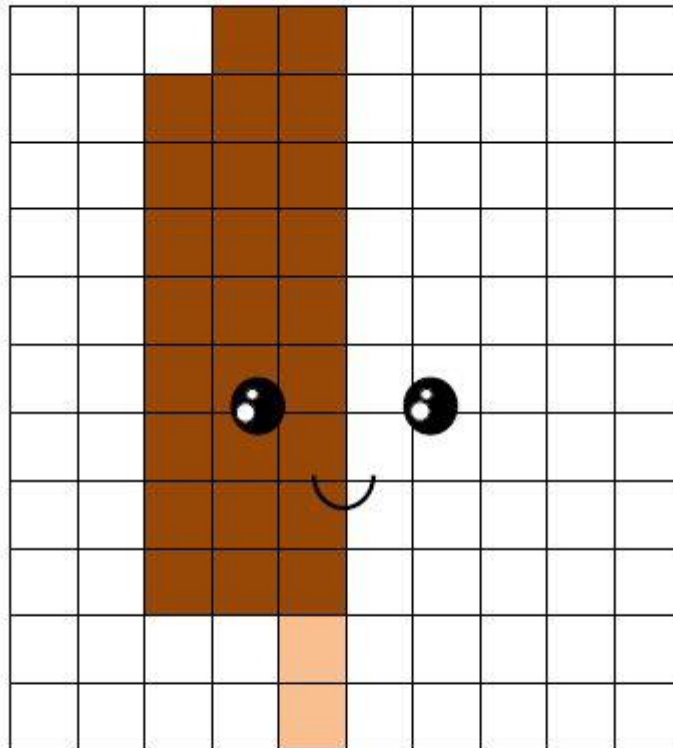

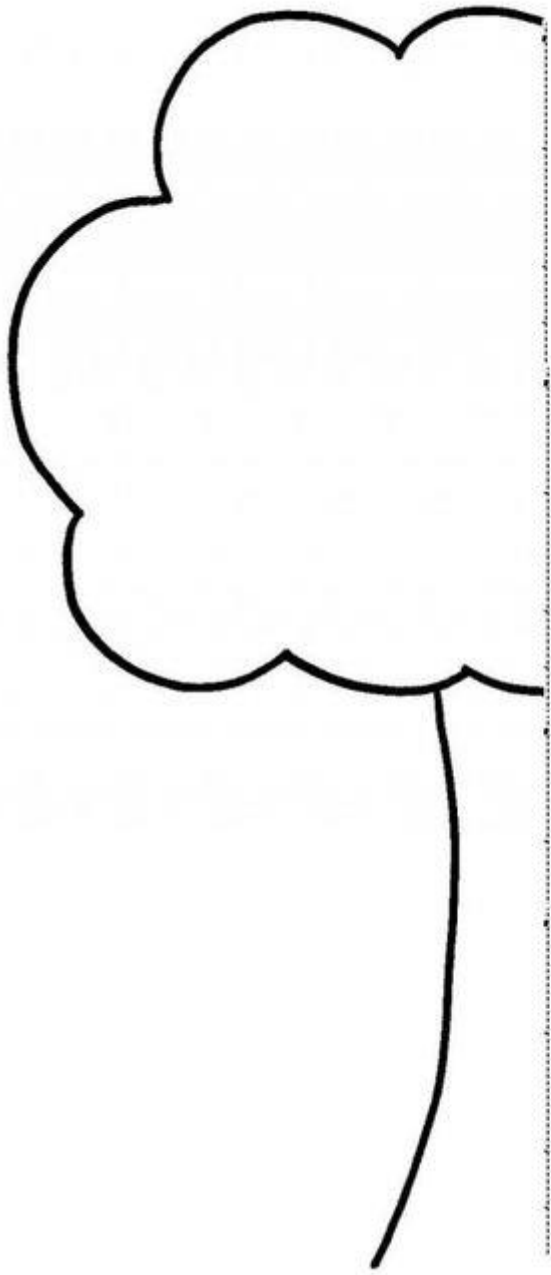

**SYMMETRY
DRAWING**

Name: _____
Finish the drawing around the line of symmetry.

